

# T450 | T590

COMPACT TRACK LOADERS

K-Series M-Series R-Series



*One Tough Animal*

# INTRODUCTION

# ONE TOUGH ANIMAL



## BOBCAT'S HISTORY

In 1958, Melroe Manufacturing Company introduced a compact front-end loader that evolved quickly into the M400, the world's first true skid steer loader. The company soon adopted what became the world-famous 'Bobcat' brand – and its success paved the way for the global compact equipment industry we know today.

## INNOVATION CENTER IN CZECH REPUBLIC

New technologies and machines are rigorously tested to take on the toughest jobs.



## BOBCAT TODAY

Since introducing our first compact track loader in 1999, the new category quickly gained popularity thanks to Bobcat's decades of experience building compact loaders to the highest standards.



## OUR MISSION

We empower operators to accomplish more, while working in the toughest conditions and tightest situations. When our customers have the will, we provide the way.

# BUILT FOR ALL CONDITIONS

## ▶ OUTPERFORM ANY ENVIRONMENT

Bobcat Compact Track Loaders bring a host of performance, productivity and durability features to help you accomplish jobs that would be impossible for conventional wheeled loaders.



ROPS/FOPS protection

Optional pressurized enclosed cab with heating and air-conditioning

Remote control ready to allow advanced operation of the machine and attachments

State-of-the-art machine and attachments operation thanks to Selectable Joystick Controls option

Auto Ride Control option brings lift arms dampening effect

High-Flow Hydraulics option to double the hydraulic flow for attachments

Temporarily reverse the cooling fan direction with auto reversing fan option

Change attachments in less than a minute without leaving your seat with Hydraulic Power Bob-Tach™ option

Durable tailgate

Over 100 attachments for any kind of job **P.16**

Track selection to fit all job sites

Bucket positioning keeps your bucket level when raising lift arms



### ▶ POWERFUL YET COMPACT

Compact footprint provides surprisingly high performance and outstanding lift capacity.



### ▶ ROCK SOLID AND STABLE

Unparalleled stability is critically important for applications where precision is key.



### ▶ UNMATCHED COMFORT

Get comfortable with several seat options, optional air conditioning and pressurized cab to keep the dust out. **P.8**



### ▶ MAXIMUM UPTIME

A reliable, time-proven design and easy maintenance thanks to 60 years of innovation. **P.10**

## POWER WHERE YOU NEED IT

### ► GENTLE WHEN REQUIRED

The tracks' low ground pressure allows travel over sensitive areas. Increased traction ensures grip in mud or on unprepared sites and improves productivity with ground engaging attachments.



### ► TRULY ALL-TERRAIN

The M-Series' grip, weight distribution and optimized footprint allow travel and performance in places where other machines cannot go – uneven terrain, trenches or inclines up to 35% or 20°.



## PERFORMANCE



### ► HIGH PERFORMANCE AT YOUR FINGERTIPS

Thanks to advanced features such as high-flow for using a variety of attachments, auto ride control for increased comfort and less spillage, and reverse fan for work in dusty environments.

### ► STAGE V ENGINES

Time-tested Bobcat engine technology is now Stage V compliant. Engine's compact size now packs higher torque at lower RPM while ensuring low noise levels for increased comfort. Fast recovery from overload and low fuel consumption boost your effectiveness even further.



# STEP INSIDE



## ► PRESSURIZED CAB

Designed for demanding environments, pressurized cab option ensures that dust and dirt are kept out. With storage space and a 12V charger, this easy-to-clean cab is built to make tough jobs comfortable.

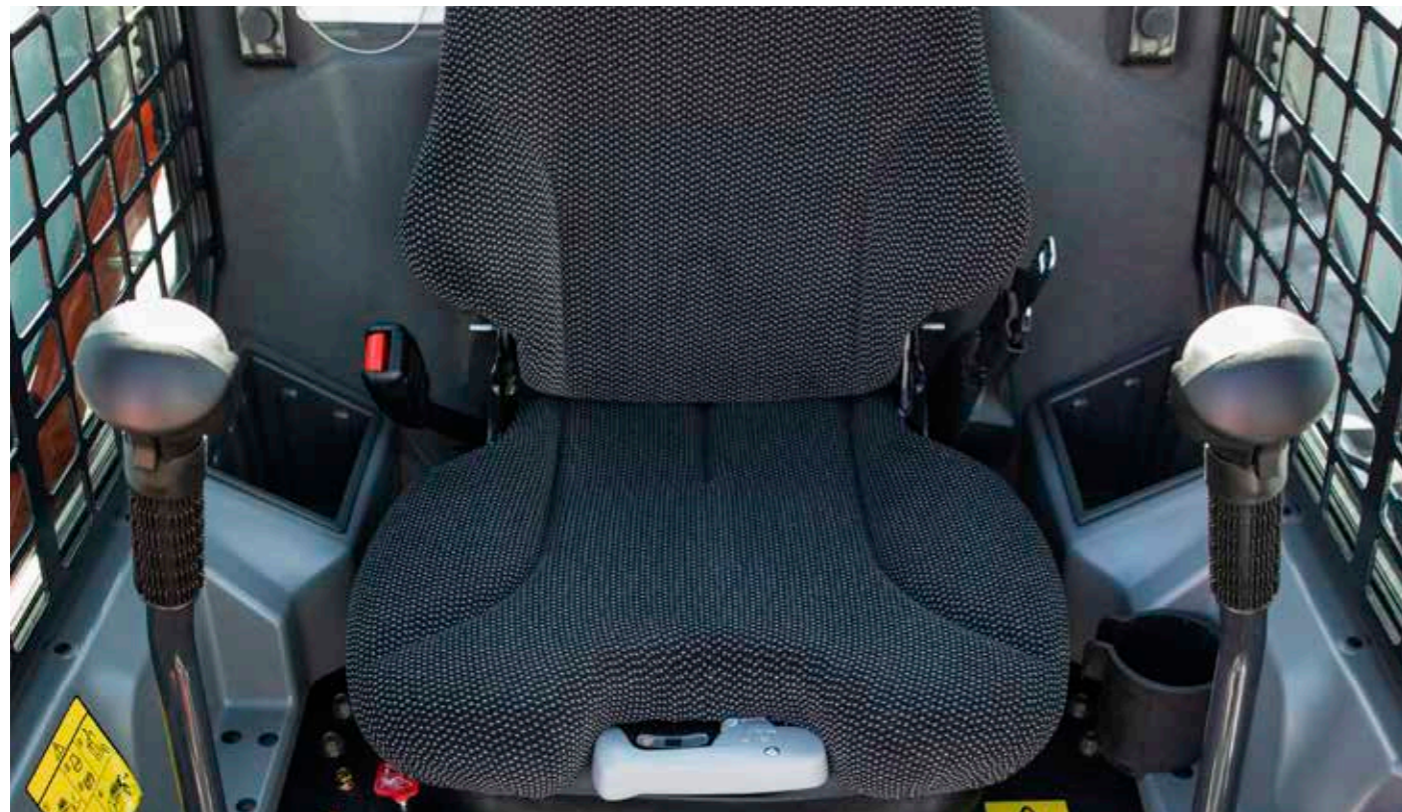

## ► IN ALL WEATHER CONDITIONS



Stay focused on the job all year round thanks to the direct cab temperature control that comes with air conditioning and heater options.

## ► DELUXE DASHBOARD



Intuitive easy-to-read control panel and keyless ignition come as standard for enhanced convenience and security.

## ► PERFECT SEAT



Work comfortably all day with ergonomic, easily adjustable seats with suspension options.

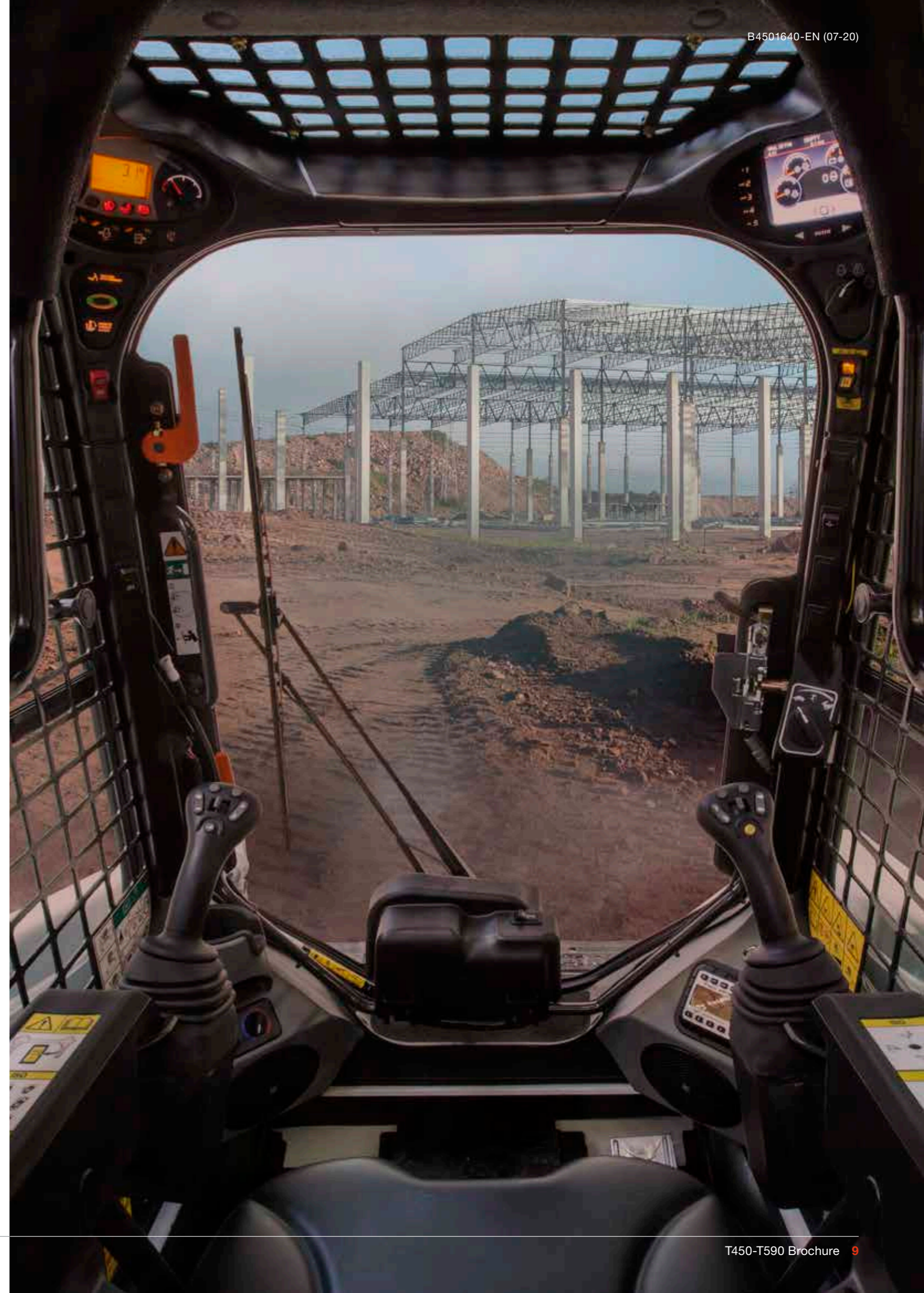

# BUILT TO LAST

## ▶ LONGER UPTIME

Bobcat loaders rely on a range of features that help minimize maintenance and protect your machine: self-diagnostics, machine shutdown protection, battery run-down protection, cold weather protection and other features. What's more, M-Series track loaders feature long-lasting tracks and reliable undercarriage, which further increases uptime and gives you added peace of mind.

## ▶ EXTENDED SERVICE INTERVALS

Improve efficiency and reduce your operating costs thanks to extended service intervals. Bobcat recommends first service after 500 hours of operation.



## ▶ MACHINE IQ

BOBCAT® Machine IQ Wireless Communications enhances the support for your Bobcat machine.

- Durable built-in monitoring electronics
- Data are available to our machine monitoring specialist
- Maintenance is optimized for your business
- Data-driven services maximize uptime

## ▶ STANDARD WARRANTY

Bobcat Company develops every machine to the highest standards of quality and durability. That's why our standard warranty provides 24 months or 2000 operating hours (whichever occurs first) of coverage.

# THERE'S NO TIME FOR DOWNTIME. STAND UP TO THE HARSHTEST CONDITIONS. DAY AFTER DAY.



## ▶ PROTECTION PLUS EXTENDED WARRANTY

Enjoy total peace of mind with a Protection Plus® extended warranty. Providing the same level of protection as the standard warranty, Protection Plus also reflects different customer needs and expectations by offering a choice of durations and annual operating hours. According to your needs, you can benefit from the coverage for up to 5 years or 6000 engine hours. And Protection Plus is transferrable – so it will likely increase your machine's resale value.



## ▶ BOBCARE

A long-running machine starts with proper planned maintenance which helps protect against repair costs and unplanned failures when you're counting on your machine to work.

- Avoid risk by preventing major repairs and complete failures.
- Accomplish more by reducing downtime and increasing your productivity and profitability.

## T450

### ► COMPACT AND VERSATILE

With a tipping load of 2049 kg and optimized weight-to-power ratio, the T450 packs a punch despite being our smallest machine. Equipped with radial lift (designed for ground versatility) and air conditioning to make work more pleasant in any weather.



### ► MADE TO GO WHERE THE WORK IS



# CHOOSE YOUR ANIMAL

## T590

### ► THE POWER TO TACKLE ANY JOB

Take the most demanding jobs head-on, thanks to a powerful engine, exceptionally high tipping load of 2773 kg, and a High-Flow option. Equipped with vertical lift designed for stability in high reach, the T590 is surprisingly compact and light, making it suitable for a wide range of applications.



### ► CONQUER ANY CHALLENGE



# STANDARD EQUIPMENT



## FOR BOTH MODELS

- Automatically activated glow plugs
- Auxiliary hydraulics: variable flow/maximum flow
- Bobcat Interlock Control System (BICS)
- Bob-Tach™ frame
- CE certification
- Cushioned lift and tilt cylinders
- Deluxe instrument panel
- Deluxe operator cab\* - Includes interior cab foam, side, top and rear windows, Deluxe wire harness, dome light, electrical power port
- Electrically activated proportional front auxiliary hydraulics
- Engine/hydraulics system shutdown
- Keyless start with password capability
- Lift arm support
- Machine IQ (telematics)
- Manual / Instrumentation
- Noise reduction kit
- Operating lights, front and rear
- Parking brake
- Seat bar
- Seat belt
- Suspension seat
- Turbo-charger with approved spark arrestor

## FOR T450

- Tracks – rubber – 300 mm

## FOR T590

- Tracks – rubber – 320 mm
- Hydraulic bucket positioning (including ON/OFF switch)

\*Roll Over Protective Structure (ROPS) – meets requirements of SAE-J1040 and ISO 3471; Falling Object Protective Structure (FOPS) – meets requirements of SAE-J1043 and ISO 3449, Level I

# OPTIONS

## OPTIONS

	T450	T590
2 Speed	•	•
4-point lift	•	•
Attachment control	•	•
Backup alarm	•	•
Beacon	•	•
Bucket positioning	•	•
Cloth suspension seat	•	•
Custom paint color	•	•
Deluxe cab with side windows	•	•
Deluxe enclosed cab with heating	•	•
Deluxe enclosed cab with HVAC	•	•
Engine compartment seal		•
FOPS II	•	•
Front door with windshield wiper	•	•
Headlight guard	•	•
High-Flow		•
Joystick controls	•	•
LED side lights		•
Manual controls	•	•
Power Bob-Tach™	•	•
Radio	•	•
Rear auxiliary hydraulic	•	•
Rear camera with display	•	•
Rear counterweight	•	•
Rear window wiper	•	•
Reversing fan	•	•
Ride control	•	•
Road option	•	•
Single-point lift	•	•
Special applications front door	•	•
Strobe	•	•
Tail light guard	•	•
Tracks – rubber – 400 mm		•
Water tank	•	•

## PERSONALIZE YOUR MACHINE

Sometimes, we all want to add a specific functionality or a personal touch to the machine. Choose from a list of comprehensive options and customize your track loader to your heart's content!



Rubber tracks 400 mm

LED lights

Road kit



Selectable Joystick Controls (SJC)

HVAC

Rear camera

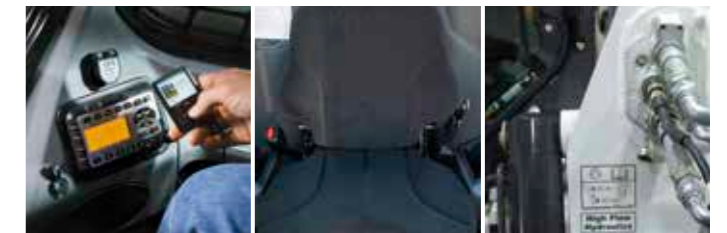

Radio

Cloth suspension seat

High-flow auxiliary hydraulics



Forestry kit

Counterweight kit

Beacon



# MULTI-TOOL CARRIER

## BOBCAT ATTACHMENTS

Get more versatility and efficiency with Bobcat attachments and implements.

- The largest choice of attachments in the industry
- Match performance to your Bobcat machine
- Work harder with stronger components and construction.
- Rest easy with the 12-month warranty on every genuine Bobcat attachment.

Actual attachment compatibility may vary based on different machine configurations. Contact your dealer for actual attachment compatibility.



Angel brooms



Box blades



Breakers



Brush saws



Combination buckets



Concrete mixers



Drop hammers



Grapples



Landplanes



Augers



Landscape rakes



Laser graders



Pallet forks



Root grapples



Remote control



Tillers



Snow blades



Tree transplanters



Stump grinders



Scrapers

# MULTI-TOOL CARRIER

ATTACHMENTS	T450	T590
Angle brooms	•	•
Augers	•	•
Backhoes	•	•
Bale forks	•	•
Box blades	•	•
Breakers	•	•
Brush saws	•	•
Brushcat™ rotary cutters	•	•
Combination buckets	•	•
Concrete mixers	•	•
Concrete pumps		•
Construction / Industrial buckets	•	•
Diggers	•	•
Dozer blades	•	•
Drop hammers		•
Dumping hoppers	•	•
Fertilizer and grain buckets	•	•
Flail cutters	•	•
Forestry cutters		•
General Purpose (GP) bucket	•	•
Graders	•	•
Grapples, industrial	•	•
Landplanes	•	•
Landscape rakes	•	•
Laser equipment	•	•
Low profile buckets	•	•
Mixing buckets		•
Mowers	•	•
Pallet forks, hydraulic	•	•
Planers		•
Remote control	•	•
Root grapples	•	•
Rotary grinders		•
Sand cleaners		•
Scarifiers	•	•
Scrapers	•	•
Skeleton buckets	•	•
Snow & light material buckets	•	•
Snow blades, pushers, V-blades	•	•
Sod layers	•	•
Soil conditioners	•	•
Spreaders	•	•
Stump grinders		•
Sweepers	•	•
Tillers	•	•
Tilt-tatch	•	•
Tree transplanters		•
Trench compactors		•
Trenchers		•
Utility forks	•	•
Utility frames	•	•
Vibratory rollers	•	•
Wheel saws		•
Whisker brooms	•	•
Wood chippers	•	•

# SPECIFICATIONS

SPECIFICATIONS		
	T450	T590
<b>MACHINE RATING</b>		
Tipping load (ISO 14397-1)	2049 kg	2773 kg
Rated operating capacity* (ISO 14397-1)	717 kg	971 kg
Ground pressure	40.0 kPa	24.1 kPa
Lift breakout force	1426 daN	2269 daN
Tilt breakout force	1781 daN	2179 daN
Push force	2388 daN	3573 daN
<b>CYCLE TIMES</b>		
Raise lift arms	2.6 s	4 s
Lower lift arms	2.4 s	2.8 s
Bucket rollback	1.5 s	1.7 s
Bucket dump	2.0 s	2.5 s
<b>WEIGHTS</b>		
Operating weight	2961 kg	3664 kg
Shipping weight	2665 kg	3283 kg
<b>ENGINE</b>		
Make / Model	Bobcat 2.4 L, 97/68 EC	Bobcat 2.4 L, 97/68 EC
Compliance	Stage V	Stage V
Fuel	Diesel	Diesel
Cooling	Liquid	Liquid
Power at 2600 RPM (ISO 14396)	41.0 kW	50.8 kW
Torque at 1800 RPM (ISO 14396)	204.2 Nm	252.3 Nm
<b>HYDRAULIC SYSTEM</b>		
Pump capacity	63.0 L/min	64.7 L/min
Pump capacity (with high flow option)	–	101.1 L/min
System relief at quick couplers	22.4-23.1 L/min	23.8-24.5 MPa
<b>TRACTION</b>		
Max. travel speed (low range – standard)	10.0 km/h	10.4 km/h
Max. travel speed (high range – optional)	14.4 km/h	16 km/h
<b>FLUID CAPACITIES</b>		
Fuel tank	64.9 L	138.2 L
Hydraulic / Hydrostatic system	21.0 L	36 L
<b>ENVIRONMENTAL</b>		
Operator LpA (98/37 & 474-1)	85 dB(A)	82 dB(A)
Noise level LWA (EU Directive 2000/14/EC)	101 dB(A)	101 dB(A)
Whole body vibration (ISO 2631-1)	1.00 ms <sup>-2</sup>	0.84 ms <sup>-2</sup>
Hand-arm vibration (ISO 5349-1)	2.42 ms <sup>-2</sup>	2.29 ms <sup>-2</sup>

\* Rated operating capacity is 35% of the tipping load.

Certain specification(s) are based on engineering calculations and are not actual measurements. Specification(s) are provided for comparison purposes only and are subject to change without notice. Specification(s) for your individual Bobcat equipment will vary based on normal variations in design, manufacturing, operating conditions, and other factors. Pictures of Bobcat units may show other than standard equipment.

# SPECIFICATIONS

## DIMENSIONS

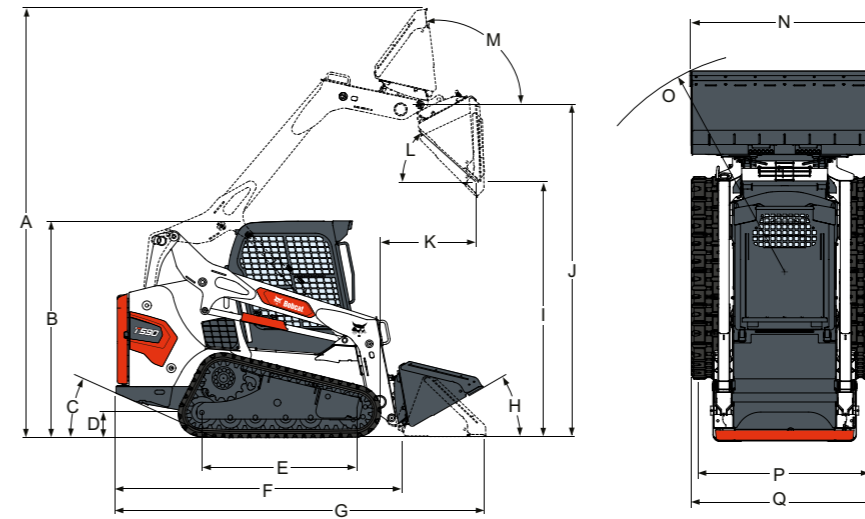

DIMENSIONS		
	T450	T590
<b>A</b>	3604	3901
<b>B</b>	1976	1972
<b>C</b>	28.0°	27.8°
<b>D</b>	213	188
<b>E</b>	1275	1402
<b>F</b>	2499	2657
<b>G</b>	3216	3378
<b>H</b>	26.0°	30.0°
<b>I</b>	2129	2319
<b>J</b>	2781	3023
<b>K</b>	597	887
<b>L</b>	40.0°	42.0°
<b>M</b>	91.0°	97.0°
<b>N</b>	1422	1727
<b>N*</b>	1575	1880
<b>O</b>	1979	2032
<b>P</b>	1097	–
<b>Q</b>	1397	1702
<b>Q*</b>	–	1782

Unit: mm



# FINANCING OPTIONS

## ► 24, 36, 48, OR 60-MONTH FINANCING\*

Improve your cashflow by taking advantage of 24, 36, 48 or 60-month financing programs starting from 0% interest. Ask your dealer for the financing offers available.

# 150 ATTACHMENTS 63 MACHINES 1 TOUGH ANIMAL

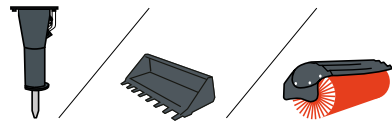

## ► DESIGNED TO DO MORE

Bobcat offers the widest range of attachments for all your needs in Construction, Landscaping, Agriculture, Road, Material Handling and Forestry.



**SKID STEER  
LOADERS**

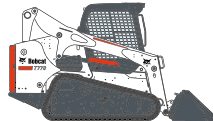

**COMPACT TRACK  
LOADERS**



**MINI TRACK  
LOADER**



**TELEHANDLERS**



**COMPACT EXCAVATORS**

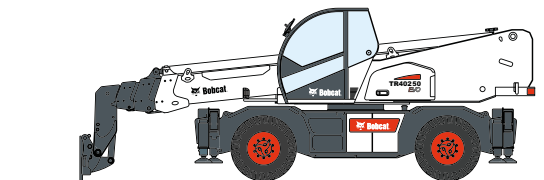
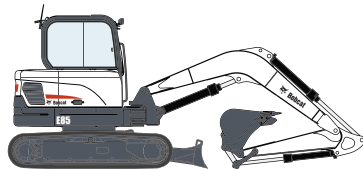

**ROTARY TELESCOPIC HANDLERS**



# Bobcat®

### Bobcat is a Doosan Company.

Doosan is a global leader in construction equipment, power & water solutions, engines, and engineering proudly serving customers and communities for more than a century. | Bobcat and the Bobcat logo are registered trademarks of Bobcat Company in the United States and various other countries. ©2020 Bobcat Company. All Rights Reserved.

\*Financing options may vary by country and dealer. Always ask your dealer about currently available financing options. Terms and conditions may apply.



# BE OM **EN OFFERT**

Klicka bara på **knappen** eller skanna **QR-koden** nedan för åtkomst till vårt offertformulär.

Vi kontaktar dig så snart som möjligt. Tack!



**BEGÄR OFFERT**

