

S66 | S76

SKID STEER LOADERS

K-Series M-Series **R-Series**

Europe



One Tough Animal

INTRODUCTION

ONE TOUGH ANIMAL



BOBCAT'S HISTORY

In 1958, Melroe Manufacturing Company introduced a compact front-end loader that evolved quickly into the M400, the world's first true skid steer loader. The company soon adopted what became the world-famous 'Bobcat' brand – and its success paved the way for the global compact equipment industry we know today.

CONTINUOUS INNOVATION

New technologies and machines are rigorously tested in our innovation facilities to take on the toughest jobs.



BOBCAT TODAY

With over 60 years of experience in manufacturing and continuously improving the world's most popular loaders, we've shipped over 1 million machines to the market. Our loaders are synonymous with high performance, reliability and unmatched comfort.



OUR MISSION

We empower operators to accomplish more, while working in the toughest conditions and tightest situations. When our customers have the will, we provide the way.

PERFORMANCE AND AGILITY MEET SMART TECH

► TOUGHNESS MEETS INNOVATION

Using decades of experience developing the toughest loader on the planet, we added a host of improvements and smart technology to increase durability, boost performance, and bring first-class comfort to the all-new R-Series loaders.



LED lights with optional Premium LED with corner view

Optional side LED lights

Optimized design for greater visibility without compromising durability

Clear-view cab option for advanced visibility

Auto Ride Control option brings lift arms dampening effect

Cast steel arms for better visibility while keeping the outstanding durability

Improved cooling for improved performance and reliability

Compatible with a full range of over 100 attachments thanks to standardized Bob-Tach™ technology

Robust transmission with the proven design of the maintenance-free drive chains

Attachments are automatically leveled when moving up or down thanks to dual bucket positioning

One-piece cast upgraded Bob-Tach™ with integrated debris shredder



► **AGILE AND STRONG**
Outstanding lift capacity with high pushing and breakout forces, complemented by excellent machine agility.



► **BUILT TOUGH**
One-piece cast steel loader arms and upgraded Bob-Tach™ with integrated debris shredder are designed for the most challenging conditions.



► **FIRST CLASS COMFORT**
Connectivity options and soundproof cab make staying in touch easy, while longer wheel base delivers a smoother ride.



► **IMPROVED VISIBILITY**
New cab construction is optimized for maximum visibility, further expandable by clear-view cab or rear-view camera options.

POWER WHERE YOU NEED IT

► AGILE AND POWERFUL

Bobcat loaders have always been made to go where the work is. They are renowned for their compact size, maneuverability and smooth controls – but Bobcat never stops innovating. Each generation of machines is stronger, faster and more durable than the last. Together with our legendary attachments, R-Series loaders take productivity even further and are ready to conquer any challenge.



OUTSTANDING PERFORMANCE

► IMPROVED COOLING

The R-Series cooling system is completely redesigned for optimal operation and uptime. The fan is almost 50% bigger and comes with a reversible option, increasing productivity in dirty conditions.

► INCREASED LIFTING CAPABILITIES

Thanks to the longer wheelbase and a perfect balance between weight and horsepower, the R-Series features outstanding stability and enough lift capacity for any job site.



STEP INSIDE



► CLEAR-VIEW CAB
 The optional clear side enclosure adds thick polycarbonate side windows with abrasion-resistant coating – maximizing your visibility and ensuring the best possible view of tracks and corners.



► INTUITIVE TOUCH CONTROLS



Take control of all settings with the optional glove-sensitive 7-inch display. New display is waterproof and scratch resistant.

► ADVANCED CONNECTIVITY



Connect your phone – thanks to the integrated Bluetooth – and enhance your comfort during calls or play your favorite music.

► PERFECT SEAT



Comfortable suspension seat as a standard and optional cloth heated air-ride seat for maximum comfort all day – and all year – long.

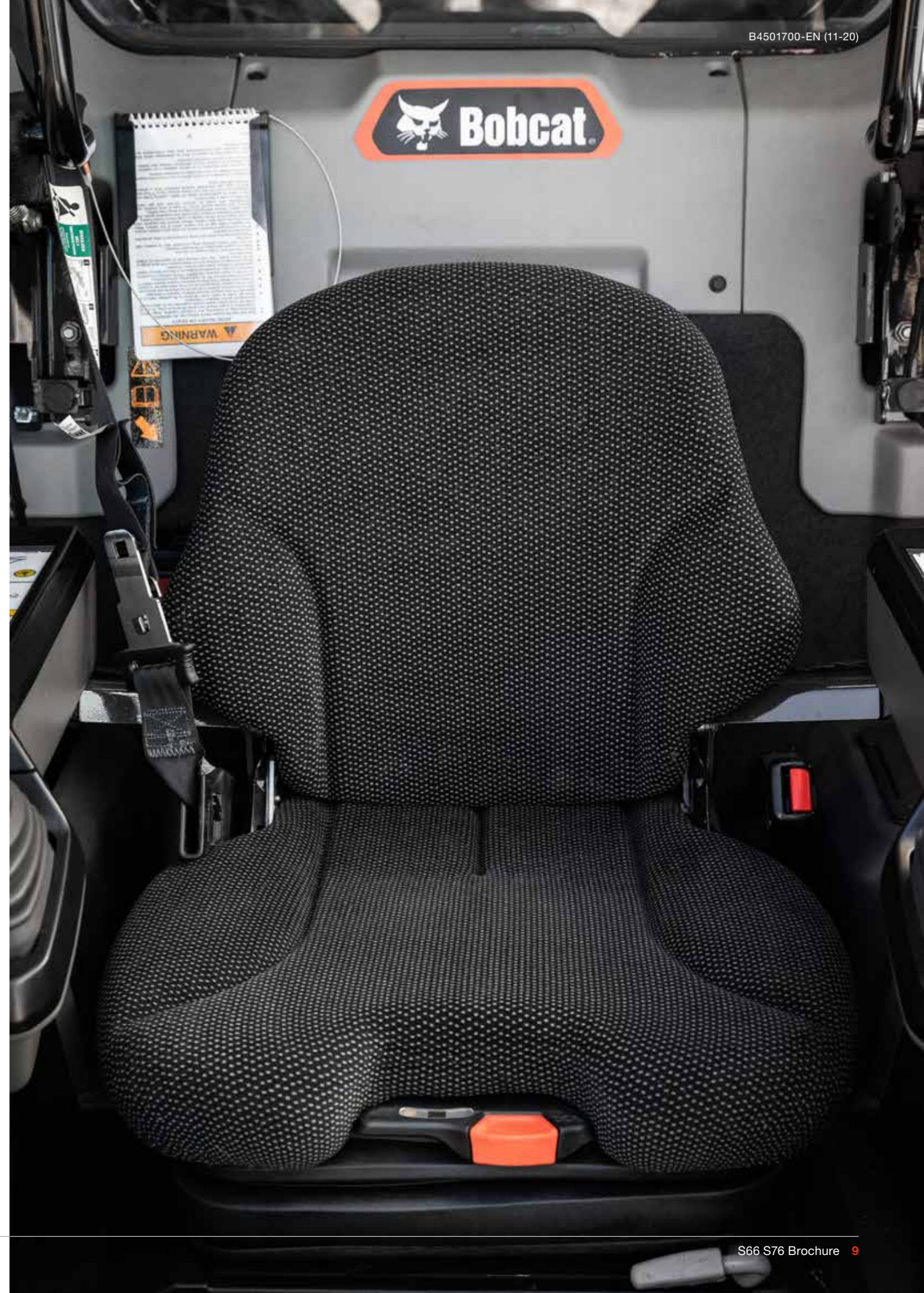

BUILT TO LAST

▶ OUTSTANDING UPTIME

R-Series loaders feature an extremely durable transmission with welded axle carrier and proven maintenance-free drive chain. It's unibody steel frame with integrated chain case makes the machines suitable for daily work in the most demanding environments, such as demolition sites and other industrial applications.

With a special focus on uptime, the R-Series features many small improvements that minimize maintenance and protect your machine: self-diagnostics, machine shutdown protection, battery run-down protection, cold weather protection, improved lubrication and access to greasing points, improved protection of hoses, and more.

▶ EXTENDED SERVICE INTERVALS

R-Series loaders feature a new fuel filter with more than double the media surface area, protecting the system even better and greatly extending the life of the filter. The improved engine design also significantly lengthens the air filter's life. This and other features allow you to improve efficiency and reduce operating costs, thanks to extended service intervals. Bobcat recommends first service after 500 hours of operation.



▶ MACHINE IQ

BOBCAT® Machine IQ Wireless Communications enhances the support for your Bobcat machine.

- Durable built-in monitoring electronics
- Data is available to our machine monitoring specialist
- Maintenance is optimized for your business
- Data-driven services maximize uptime

▶ STANDARD WARRANTY

Bobcat develops every machine to the highest standards of quality and durability. That's why our standard warranty provides 24 months or 2000 operating hours (whichever occurs first) of coverage.

THERE'S NO TIME FOR DOWNTIME. STAND UP TO THE HARSHTEST CONDITIONS. DAY AFTER DAY.



▶ PROTECTION PLUS EXTENDED WARRANTY

Enjoy total peace of mind with Protection Plus® extended warranty. Providing the same level of protection as the standard warranty, Protection Plus also reflects different customer needs and expectations by offering a choice of durations and annual operating hours. According to your needs, you can benefit from the coverage for up to 5 years or 6000 engine hours. And Protection Plus is transferrable – so it will likely increase your machine's resale value.



▶ BOBCARE

A long-running machine starts with proper planned maintenance, which helps protect against repair costs and unplanned failures when you're counting on your machine to work.

- Avoid risk by preventing major repairs and complete failures.
- Accomplish more by reducing downtime and increasing your productivity and profitability.

S66

► COMPACT YET POWERFUL

Despite its compact footprint, the S66 offers a surprising amount of power with a lift capacity of 1165 kg while running on the same reliable engine as the S76.



► PUNCH IN A COMPACT FRAME



CHOOSE YOUR ANIMAL

S76

► POWER MEETS CONTROL

With a lift capacity of 1365 kg, the S76 is designed to do more, even in the most demanding environments. Combined with a superior hydraulic performance for maximum effectiveness, even with the heaviest and most power-hungry attachments.



► THE POWER TO TACKLE EVERY JOB



STANDARD EQUIPMENT



FOR BOTH MACHINES

- 3-point seat belt
- 5" Deluxe instrumentation (radio ready)
- Adjustable suspension seat
- Auxiliary hydraulics: variable flow/maximum flow
- Backup alarm
- Bob-Tach™ attachment system
- Bobcat Interlock Control System (BICS)
- Deluxe pressurized cab with HVAC
- Dual Direction Bucket Positioning (including ON/OFF switch)
- Engine/hydraulics system shutdown
- High flow hydraulics
- Horn
- Key start
- LED working lights front and rear
- Lift arm support
- Machine IQ (telematics)
- Operating manual
- Parking brake
- Seat bar
- Selectable Joystick Controls (SJC)
- Spark arrestor muffler
- Two speed travel
- Warranty: 24 months or 2000 hours (whichever occurs first)

FOR S66

- 10 × 16.5, 10-ply, heavy-duty tires

FOR S76

- 12 × 16.5, 10-ply, heavy-duty tires

*Roll Over Protective Structure (ROPS) – meets requirements of SAE-J1040 and ISO 3471; Falling Object Protective Structure (FOPS) – meets requirements of SAE-J1043 and ISO 3449, Level I

OPTIONS

OPTIONS

	S66	S76
10 × 16.5, 10-ply, heavy-duty tires, offset rims	•	
10 × 16.5, 10-ply, severe-duty tires	•	
10 × 16.5, Solid Flex tires	•	
31 × 12 × 16.5, 10-ply, super float tires	•	
12 × 16.5, 10-ply, heavy-duty tires, offset rims		•
12 × 16.5, 10-ply, severe-duty tires		•
12 × 16.5, solid flex tires	•	•
14-pin attachment control kit	•	
200 lbs (74.4 kg) counterweight kit	•	
300 lbs (111.9 kg) counterweight kit		•
4-way flasher kit	•	
7" touch display		•
Auto HVAC	•	•
Auto Ride Control	•	•
Beacon	•	•
Clear-view cab	•	•
Engine block heater kit	•	•
Fire extinguisher kit	•	•
FOPS kit *	•	•
Four-point lift kit	•	•
Front axle counterweight kit	•	•
Headlight guard kit	•	•
Heated cloth air ride seat with 3 point seat belt	•	•
Keyless kit	•	•
LED side lighting kit	•	•
Lexan rear window kit	•	•
Manual hand and foot controls	•	•
Power Bob-Tach™	•	•
Premium LED lights (with corner view)	•	•
Radio	•	•
Rear auxiliary hydraulic kit	•	•
Reversible fan	•	•
Reversing camera	•	•
Road kit	•	•
Single-point lift kit	•	•
Special applications front door kit	•	•
Strobe	•	•
Tail light guard kit	•	•

PERSONALIZE YOUR MACHINE

Sometimes, we all want to add a specific functionality or a personal touch to the machine. Choose from a list of comprehensive options and customize your loader to your heart's content!



7" touch display

Auto HVAC

Auto Ride Control



Clear-view cab

Headlight guard kit

Lexan rear window kit



LED side lighting kit

Power Bob-Tach™

Premium LED lights (with corner view)



Reversible fan

Reversing camera

Tail light guard kit

MULTI-TOOL CARRIER

BOBCAT ATTACHMENTS

Get more versatility and efficiency with Bobcat attachments.

- The largest choice of attachments in the industry.
- Match performance to your Bobcat machine.
- Work harder with stronger components and construction.
- Rest easy with the 12-month warranty on every genuine Bobcat attachment.

Actual attachment compatibility may vary based on different machine configurations. Contact your dealer for actual attachment compatibility.



Angle brooms



Box blades



Breakers



Brush saws



Wheel saw



Concrete mixers



Drop hammers



Grapples



Landplanes



Forestry cutter



Landscape rakes



Tillers



Pallet forks



Root grapples



Planer



Laser graders



Snow blades



Tree transplanters



Stump grinders



Scrapers

MULTI-TOOL CARRIER

ATTACHMENTS	S66	S76
Angle brooms	•	•
Augers	•	•
Backhoes	•	•
Bale forks	•	•
Box blades		•
Breakers	•	•
Brushcat™ rotary cutters	•	•
Brush saws	•	•
Combination buckets	•	•
Concrete mixers	•	•
Construction / industrial buckets	•	•
Diggers	•	•
Dozer blades	•	•
Drop hammers		•
Dumping hoppers	•	•
Fertilizer and grain buckets	•	•
Flail cutters	•	•
General purpose (GP) bucket	•	•
Graders	•	•
Grapples, industrial	•	•
Landplanes	•	•
Landscape rakes	•	•
Laser equipment	•	•
Low profile buckets	•	•
Mixing buckets		•
Mowers	•	•
Pallet forks	•	•
Remote control	•	•
Root grapples	•	•
Scarifiers	•	•
Scrapers	•	•
Skeleton buckets	•	•
Snow & light material buckets	•	•
Snow blades, pushers, V-blades	•	•
Sod layers	•	•
Soil conditioners	•	•
Spreaders	•	•
Steel tracks		•
Stump grinders		•
Sweepers	•	•
Tillers	•	•
Tree transplanters		•
Trench compactors		•
Utility forks	•	•
Vibratory rollers	•	•
Whisker brooms	•	•
Wood chippers	•	•

SPECIFICATIONS

SPECIFICATIONS		
	S66	S76
MACHINE RATING		
Tipping load (ISO 14397-1)	2359 kg	2722 kg
Rated operating capacity (ISO 14397-1)	1184 kg	1367 kg
Pump capacity std flow (at pump RPM)	66.5 L/min	88.1 L/min
Pump capacity high flow (at pump RPM)	101.8 L/min	114.7 L/min
System relief at quick couplers	23.8-24.5 MPa	23.8-24.5 MPa
Travel speed (low)	11.8 km/h	10.9 km/h
Travel speed (high)	17.3 km/h	19 km/h
Lift arm path	vertical	
DIMENSIONS		
Length with standard bucket	3427 mm	3737 mm
Width over standard bucket	1727 mm	1880 mm
Height with operator cab	2045 mm	2079 mm
Height to bucket hinge pin	3048 mm	3259 mm
Wheelbase	1133 mm	1227 mm
ENGINE		
Make / Model	Bobcat 2.4L, 97/68 EC Stage V	
Fuel	Diesel	
Cooling	Liquid	
Power at 2600 RPM (ISO 14396)	54.5 kW	
Torque at 1800 RPM (ISO 14396)	266.3 Nm	283.9 Nm
Number of cylinders	4	
Displacement	2400 cm ³	
Fuel tank capacity	93.7 L	120 L
WEIGHTS		
Operating weight*	3271 kg	4038 kg
Shipping weight	2939 kg	3597 kg
ENVIRONMENTAL		
Operator LpA(98/37 & 474-1)	80 dB(A)	
Noise level LWA(EU Directive 2000/14/EC)	103 dB(A)	
Whole body vibration (ISO 2631-1) High speed	0.8 ms ⁻²	
Hand-arm vibration (ISO 5349-1) High speed	2.8 m ^{s⁻²}	
FORCES		
Lift breakout force	2200 daN	2608 daN
Tilt breakout force	2440 daN	2654 daN
Push Force	2758 daN	-
CYCLE TIMES		
Raise lift arms	3.8 s	3.9 s
Lower lift arms	2.5 s	2.6 s
Bucket rollback	1.7 s	
Bucket dump	2.3 s	

*Base machine with bucket, operator and full fuel tank

Certain specification(s) are based on engineering calculations and are not actual measurements. Specification(s) are provided for comparison purposes only and are subject to change without notice. Specification(s) for your individual Bobcat equipment will vary based on normal variations in design, manufacturing, operating conditions, and other factors. Pictures of Bobcat units may show other than standard equipment.

SPECIFICATIONS

DIMENSIONS

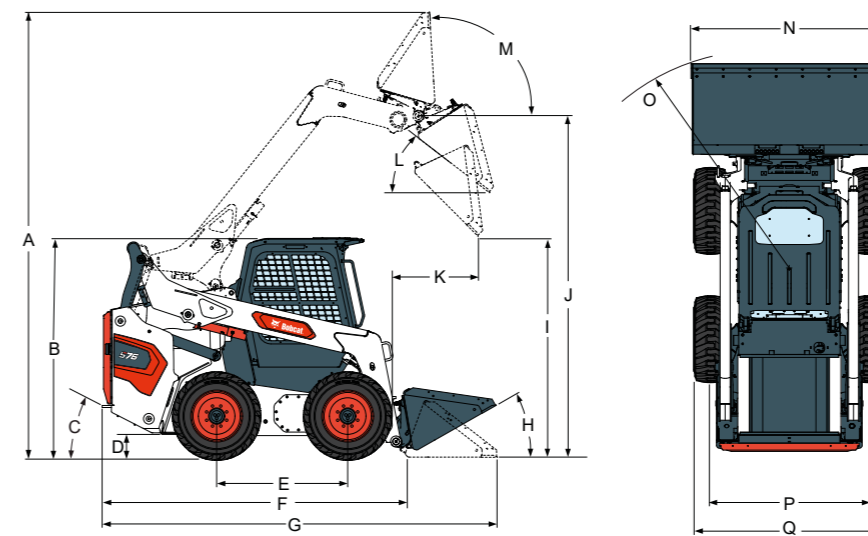

	S66	S76
A Operating height	3910	4252
B Height with operator cab	2045	2079
C Angle of departure	25°	27°
D Ground clearance	214	235
E Wheelbase	1133	1227
F Length without attachment	2718	2893
G Length with standard bucket	3427	3737
H Rollback at ground position	30°	30°
I Dump height with standard bucket	2396	2526
J Height to bucket hinge pin	3048	3259
K Dump reach at maximum height	803	950
L Dump angle at maximum height	37°	37°
M Rollback fully raised at maximum height	94°	94°
N Width over standard bucket	1727	1880
O Turning radius with standard bucket	2033	2228
P Track, standard tires	1407	1584
Q Width over standard tires	1642	1829



FINANCING OPTIONS

► 24, 36, 48, OR 60-MONTH FINANCING

Improve your cashflow by taking advantage of 24, 36, 48 or 60-month financing programs starting from 0% interest. Ask your dealer for the financing offers available.

150 ATTACHMENTS 63 MACHINES 1 TOUGH ANIMAL

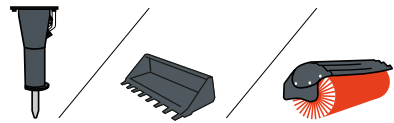

► DESIGNED TO DO MORE

Bobcat offers the widest range of attachments for all your needs in Construction, Landscaping, Agriculture, Road, Material Handling and Forestry.



**SKID STEER
LOADERS**

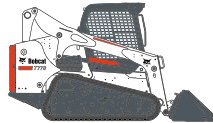

**COMPACT TRACK
LOADERS**



**MINI TRACK
LOADERS**

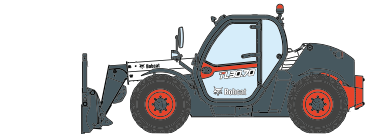

TELEHANDLERS



COMPACT EXCAVATORS

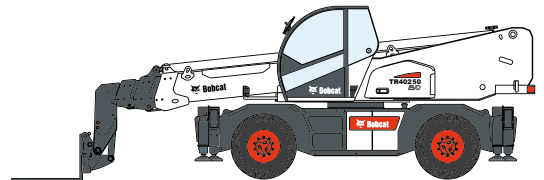
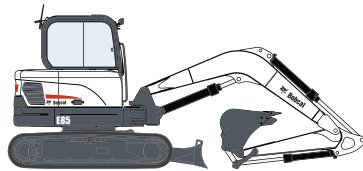

ROTARY TELESCOPIC HANDLERS



Bobcat®

Bobcat is a Doosan Company.

Doosan is a global leader in construction equipment, power & water solutions, engines, and engineering proudly serving customers and communities for more than a century. | Bobcat and the Bobcat logo are registered trademarks of Bobcat Company in the United States and various other countries. ©2020 Bobcat Company. All Rights Reserved.

*Financing options may vary by country and dealer. Always ask your dealer about currently available financing options. Terms and conditions may apply.



BE OM **EN OFFERT**

Klicka bara på **knappen** eller skanna **QR-koden** nedan för åtkomst till vårt offertformulär.

Vi kontaktar dig så snart som möjligt. Tack!



BEGÄR OFFERT

